

DATA SHEET

PSMN070-200B; PSMN070-200P N-channel TrenchMOS^(TM) transistor

Product specification

August 1999



N-channel TrenchMOS^(TM) transistor PSMN070-200B; PSMN070-200P

FEATURES

- 'Trench' technology
- Very low on-state resistance
- Fast switching
- Low thermal resistance

SYMBOL

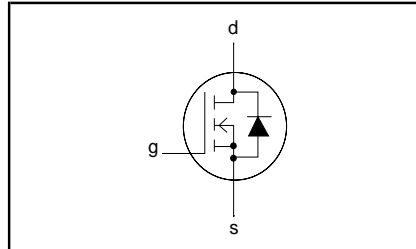

QUICK REFERENCE DATA

$V_{DSS} = 200\text{ V}$
$I_D = 35\text{ A}$
$R_{DS(ON)} \leq 70\text{ m}\Omega$

GENERAL DESCRIPTION

SiliconMAX products use the latest Philips Trench technology to achieve the lowest possible on-state resistance in each package at each voltage rating.

Applications:-

- d.c. to d.c. converters
- switched mode power supplies

The PSMN070-200P is supplied in the SOT78 (TO220AB) conventional leaded package.
The PSMN070-200B is supplied in the SOT404 surface mounting package.

PINNING

PIN	DESCRIPTION
1	gate
2	drain ¹
3	source
tab	drain

SOT78 (TO220AB)

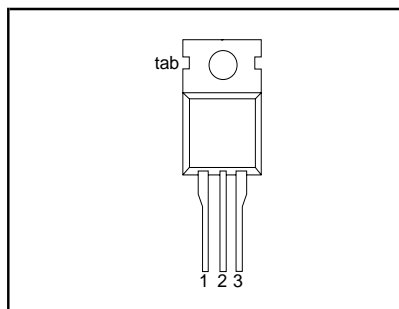

SOT404 (D²PAK)

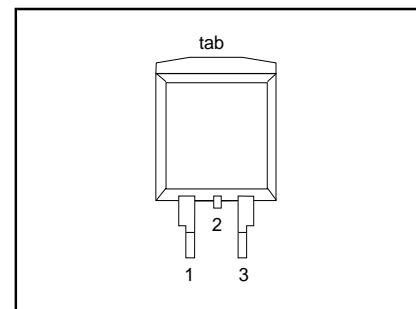

LIMITING VALUES

Limiting values in accordance with the Absolute Maximum System (IEC 134)

SYMBOL	PARAMETER	CONDITIONS	MIN.	MAX.	UNIT
V_{DSS}	Drain-source voltage	$T_j = 25\text{ }^\circ\text{C}$ to $175\text{ }^\circ\text{C}$	-	200	V
V_{DGR}	Drain-gate voltage	$T_j = 25\text{ }^\circ\text{C}$ to $175\text{ }^\circ\text{C}$; $R_{GS} = 20\text{ k}\Omega$	-	200	V
V_{GS}	Gate-source voltage		-	± 20	V
I_D	Continuous drain current	$T_{mb} = 25\text{ }^\circ\text{C}$	-	35	A
		$T_{mb} = 100\text{ }^\circ\text{C}$	-	25	A
I_{DM}	Pulsed drain current	$T_{mb} = 25\text{ }^\circ\text{C}$	-	140	A
P_D	Total power dissipation	$T_{mb} = 25\text{ }^\circ\text{C}$	-	250	W
T_j, T_{stg}	Operating junction and storage temperature		- 55	175	$^\circ\text{C}$

¹ It is not possible to make connection to pin:2 of the SOT404 package

Silicon MAXN-channel TrenchMOS^(TM) transistor

PSMN070-200B; PSMN070-200P

AVALANCHE ENERGY LIMITING VALUES

Limiting values in accordance with the Absolute Maximum System (IEC 134)

SYMBOL	PARAMETER	CONDITIONS	MIN.	MAX.	UNIT
E_{AS}	Non-repetitive avalanche energy	Unclamped inductive load, $I_{AS} = 35$ A; $t_p = 100$ μ s; T_j prior to avalanche = 25°C; $V_{DD} \leq 50$ V; $R_{GS} = 50$ Ω ; $V_{GS} = 10$ V; refer to fig:15	-	462	mJ
I_{AS}	Non-repetitive avalanche current		-	35	A

THERMAL RESISTANCES

SYMBOL	PARAMETER	CONDITIONS	TYP.	MAX.	UNIT
$R_{th\ j-mb}$	Thermal resistance junction to mounting base		-	0.6	K/W
$R_{th\ j-a}$	Thermal resistance junction to ambient	SOT78 package, in free air SOT404 package, pcb mounted, minimum footprint	60 50	- -	K/W K/W

ELECTRICAL CHARACTERISTICS $T_j = 25^\circ\text{C}$ unless otherwise specified

SYMBOL	PARAMETER	CONDITIONS	MIN.	TYP.	MAX.	UNIT
$V_{(BR)DSS}$	Drain-source breakdown voltage	$V_{GS} = 0$ V; $I_D = 0.25$ mA; $T_j = -55^\circ\text{C}$	200 178	- -	- -	V V
$V_{GS(TO)}$	Gate threshold voltage	$V_{DS} = V_{GS}$; $I_D = 1$ mA $T_j = 175^\circ\text{C}$ $T_j = -55^\circ\text{C}$	2.0 1.0 -	3.0 - -	4.0 - 6	V V V
$R_{DS(ON)}$	Drain-source on-state resistance	$V_{GS} = 10$ V; $I_D = 17$ A $T_j = 175^\circ\text{C}$	-	60	70 203	m Ω m Ω
I_{GSS}	Gate source leakage current	$V_{GS} = \pm 10$ V; $V_{DS} = 0$ V	-	2	100	nA
I_{DSS}	Zero gate voltage drain current	$V_{DS} = 200$ V; $V_{GS} = 0$ V; $T_j = 175^\circ\text{C}$	-	0.05	10 500	μ A μ A
$Q_{g(tot)}$	Total gate charge	$I_D = 35$ A; $V_{DD} = 160$ V; $V_{GS} = 10$ V	-	77	-	nC
Q_{gs}	Gate-source charge		-	16	-	nC
Q_{gd}	Gate-drain (Miller) charge		-	28	-	nC
$t_{d\ on}$	Turn-on delay time	$V_{DD} = 100$ V; $R_D = 2.7$ Ω ; $V_{GS} = 10$ V; $R_G = 5.6$ Ω	-	22	-	ns
t_r	Turn-on rise time		-	100	-	ns
$t_{d\ off}$	Turn-off delay time	Resistive load	-	80	-	ns
t_f	Turn-off fall time		-	90	-	ns
L_d	Internal drain inductance	Measured from tab to centre of die	-	3.5	-	nH
L_d	Internal drain inductance	Measured from drain lead to centre of die (SOT78 package only)	-	4.5	-	nH
L_s	Internal source inductance	Measured from source lead to source bond pad	-	7.5	-	nH
C_{iss}	Input capacitance	$V_{GS} = 0$ V; $V_{DS} = 25$ V; $f = 1$ MHz	-	4570	-	pF
C_{oss}	Output capacitance		-	370	-	pF
C_{riss}	Feedback capacitance		-	160	-	pF

SiliconMAXN-channel TrenchMOS^(TM) transistor

PSMN070-200B; PSMN070-200P

REVERSE DIODE LIMITING VALUES AND CHARACTERISTICS $T_j = 25^\circ\text{C}$ unless otherwise specified

SYMBOL	PARAMETER	CONDITIONS	MIN.	TYP.	MAX.	UNIT
I_S	Continuous source current (body diode)		-	-	35	A
I_{SM}	Pulsed source current (body diode)		-	-	140	A
V_{SD}	Diode forward voltage	$I_F = 25\text{ A}; V_{GS} = 0\text{ V}$	-	0.85	1.2	V
t_{rr}	Reverse recovery time	$I_F = 20\text{ A}; -di_F/dt = 100\text{ A}/\mu\text{s};$ $V_{GS} = 0\text{ V}; V_R = 30\text{ V}$	-	160	-	ns
Q_{rr}	Reverse recovery charge		-	1.0	-	μC

Silicon MAX

N-channel TrenchMOS^(TM) transistor

PSMN070-200B; PSMN070-200P

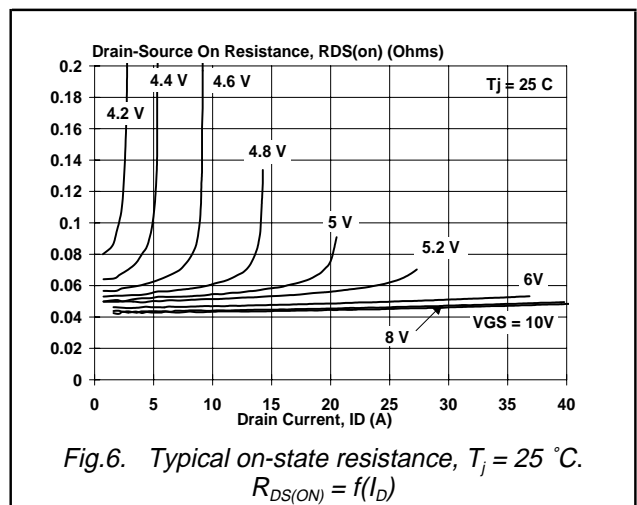
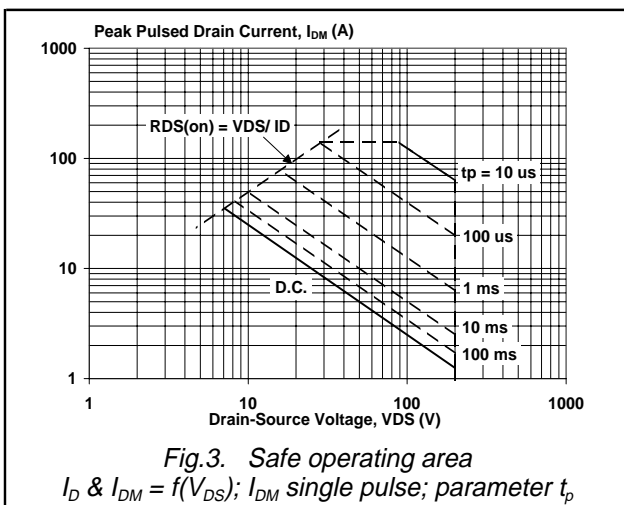
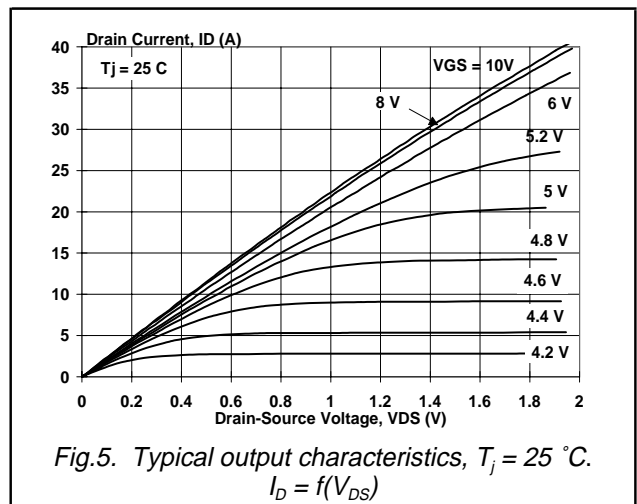
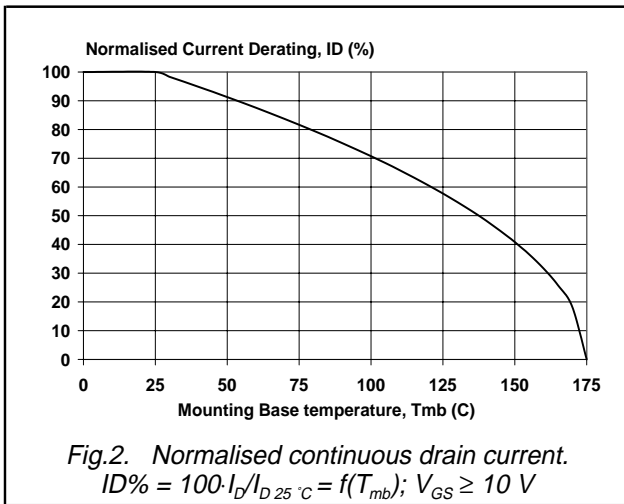
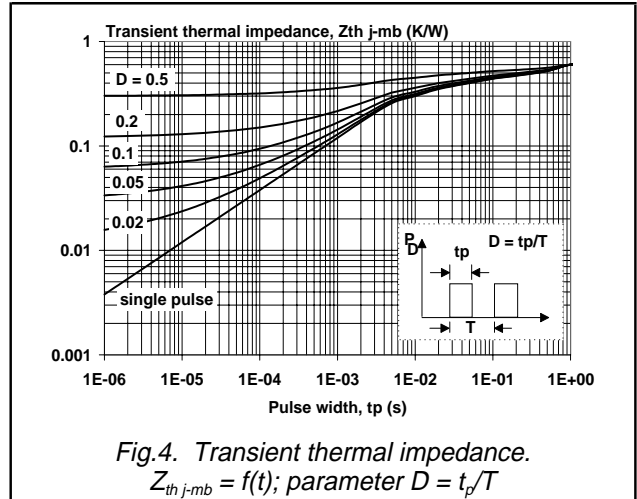
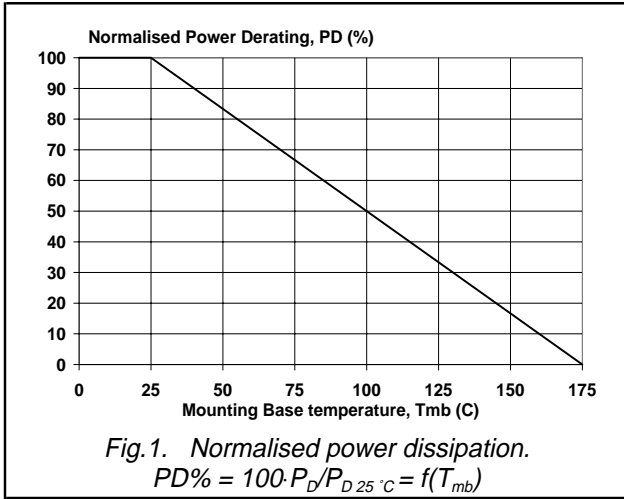



N-channel TrenchMOS^(TM) transistor

PSMN070-200B; PSMN070-200P

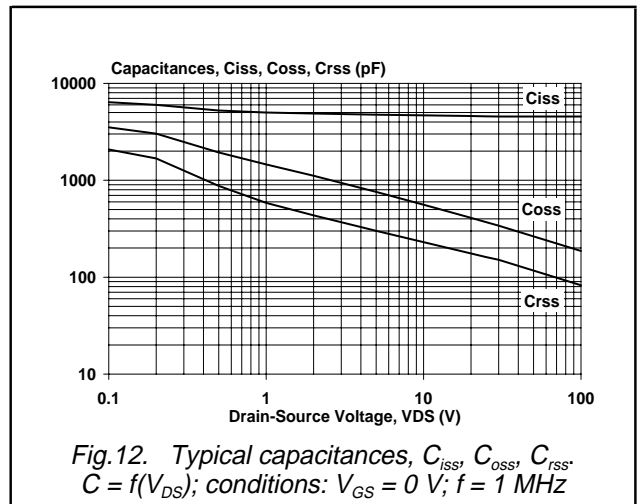
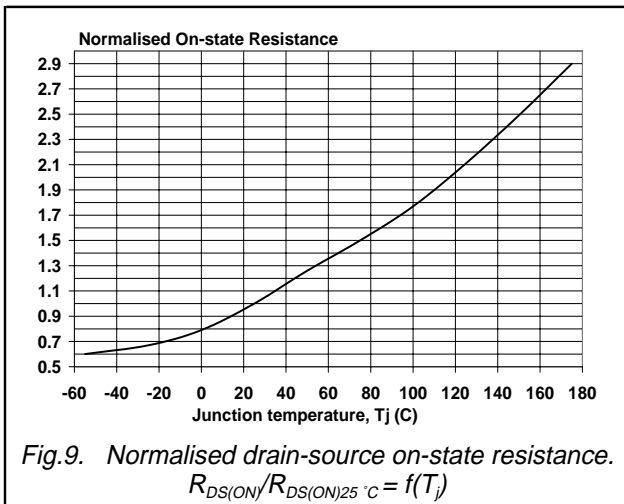
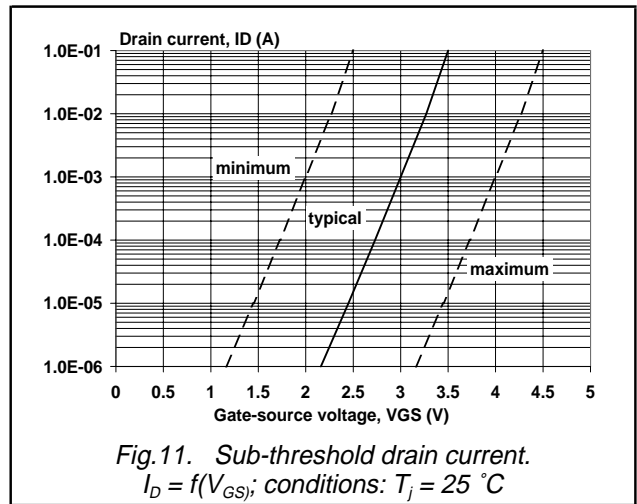
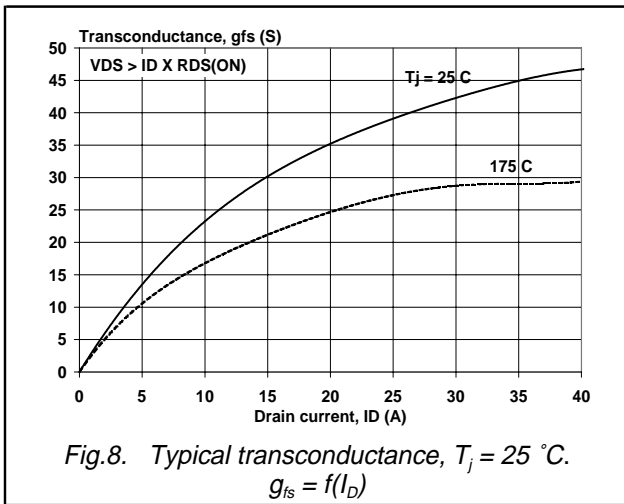
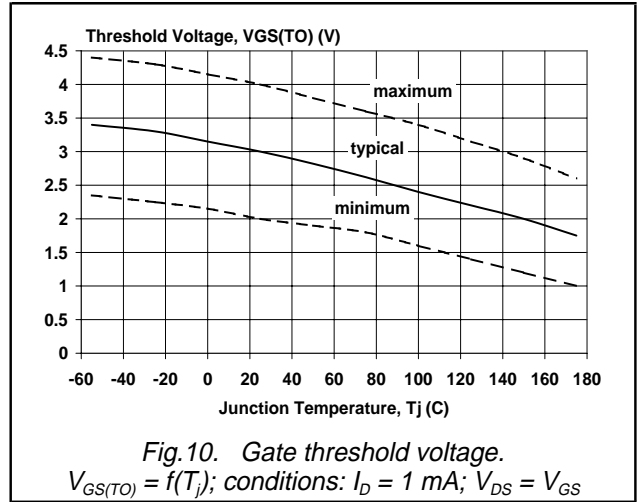
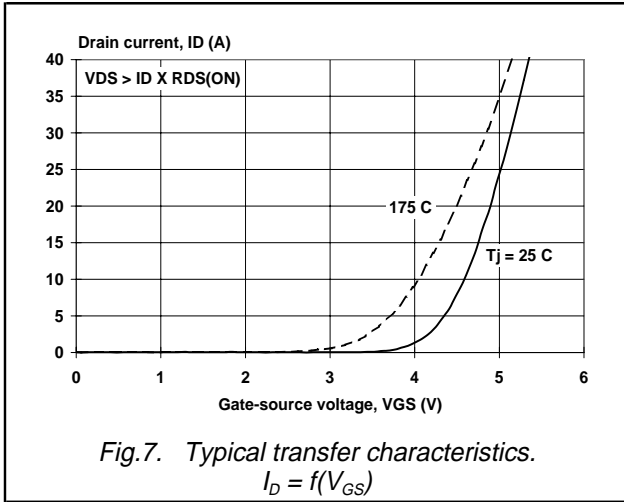

Silicon MAX

N-channel TrenchMOS^(TM) transistor

PSMN070-200B; PSMN070-200P

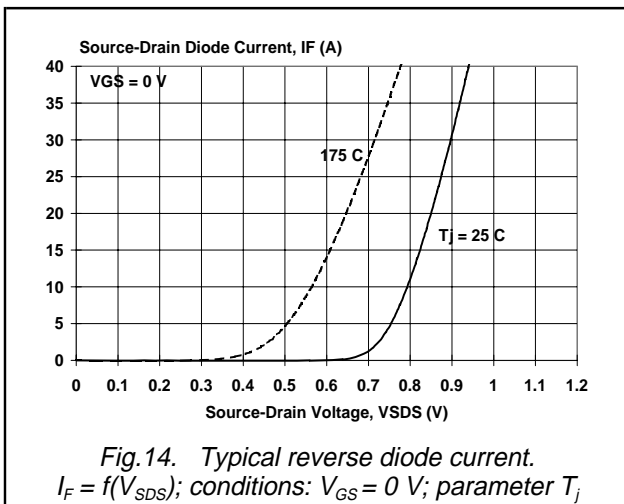
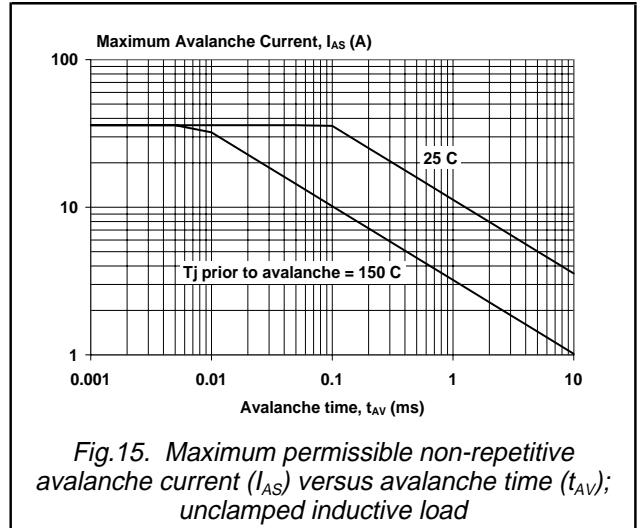
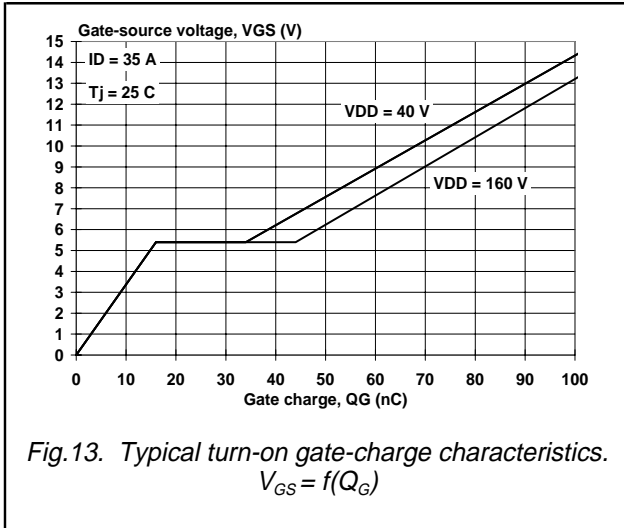



N-channel TrenchMOS^(TM) transistor

PSMN070-200B; PSMN070-200P

MECHANICAL DATA

Plastic single-ended package; heatsink mounted; 1 mounting hole; 3-lead TO-220

SOT78

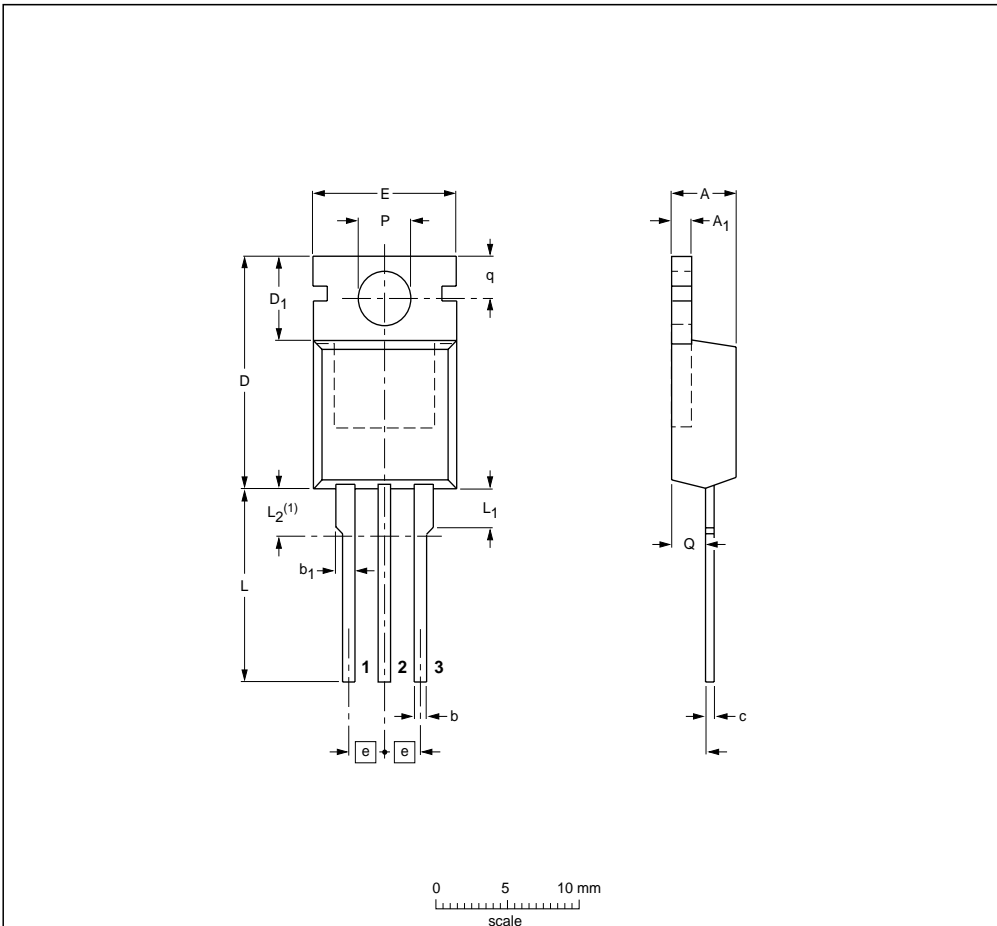

DIMENSIONS (mm are the original dimensions)

UNIT	A	A ₁	b	b ₁	c	D	D ₁	E	e	L	L ₁	L ₂ ⁽¹⁾ max.	P	q	Q
mm	4.5 4.1	1.39 1.27	0.9 0.7	1.3 1.0	0.7 0.4	15.8 15.2	6.4 5.9	10.3 9.7	2.54	15.0 13.5	3.30 2.79	3.0	3.8 3.6	3.0 2.7	2.6 2.2

Note

1. Terminals in this zone are not tinned.

OUTLINE VERSION	REFERENCES				EUROPEAN PROJECTION	ISSUE DATE
	IEC	JEDEC	EIAJ			
SOT78		TO-220				97-06-11

Fig.16. SOT78 (TO220AB); pin 2 connected to mounting base (Net mass:2g)

Notes

1. This product is supplied in anti-static packaging. The gate-source input must be protected against static discharge during transport or handling.
2. Refer to mounting instructions for SOT78 (TO220AB) package.
3. Epoxy meets UL94 V0 at 1/8".



N-channel TrenchMOS^(TM) transistor

PSMN070-200B; PSMN070-200P

MECHANICAL DATA

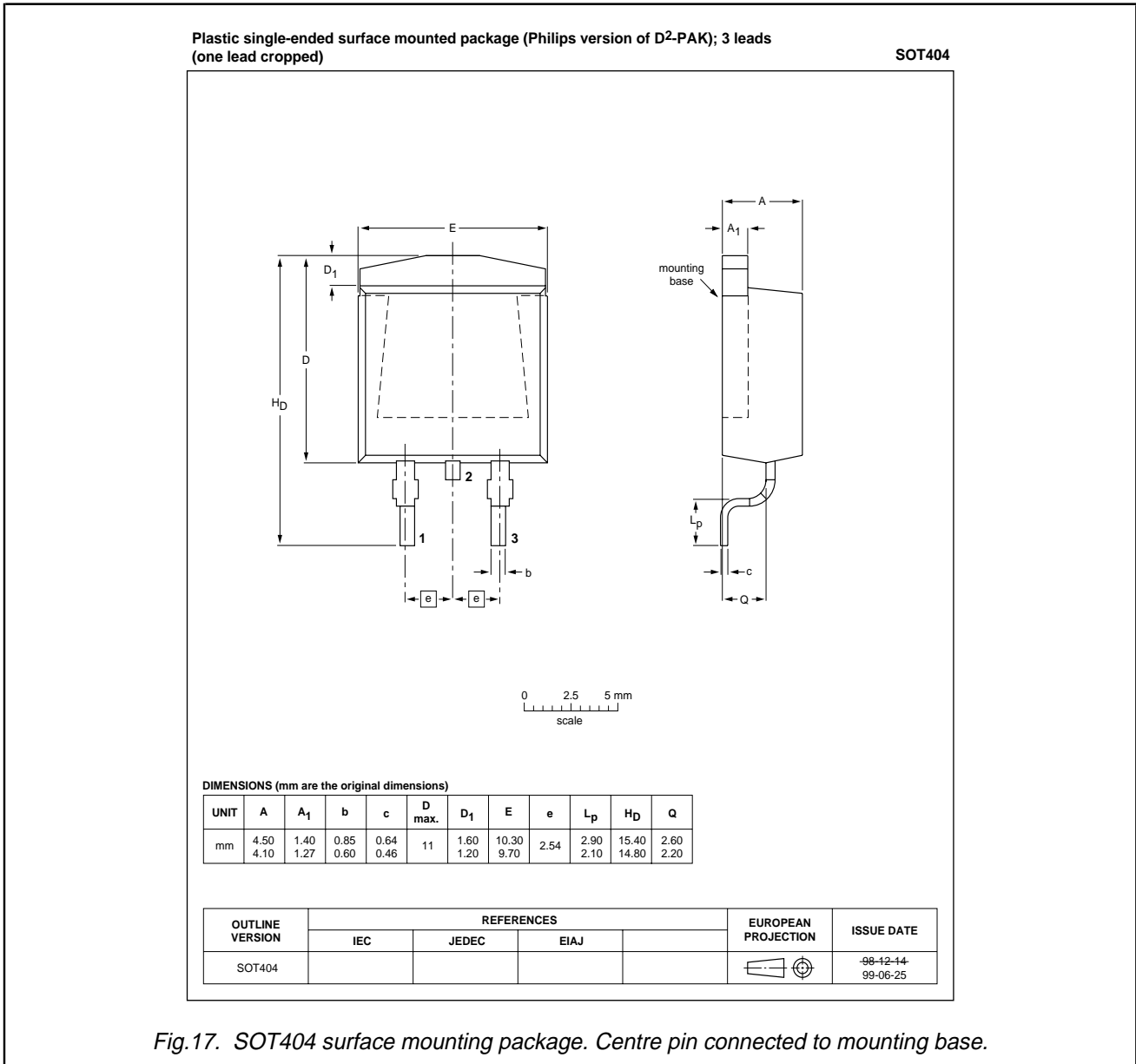

Notes

1. This product is supplied in anti-static packaging. The gate-source input must be protected against static discharge during transport or handling.
2. Refer to SMD Footprint Design and Soldering Guidelines, Data Handbook SC18.
3. Epoxy meets UL94 V0 at 1/8".

Silicon MAX

N-channel TrenchMOS^(TM) transistor

PSMN070-200B; PSMN070-200P

MOUNTING INSTRUCTIONS

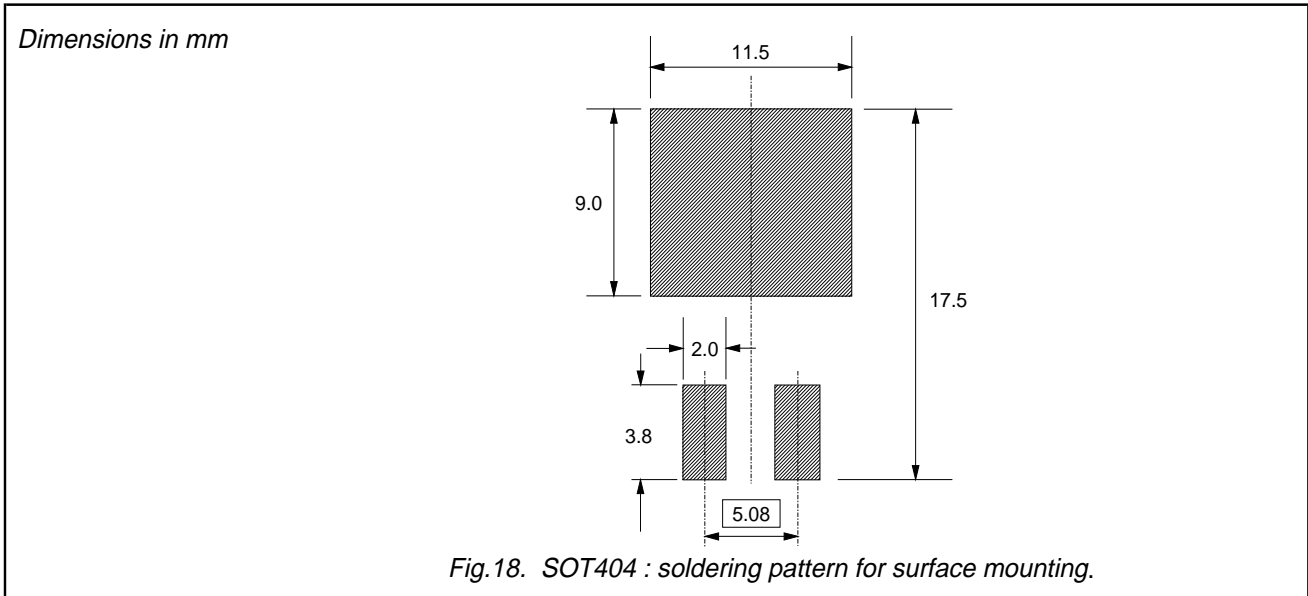

DEFINITIONS

Data sheet status	
Objective specification	This data sheet contains target or goal specifications for product development.
Preliminary specification	This data sheet contains preliminary data; supplementary data may be published later.
Product specification	This data sheet contains final product specifications.
Limiting values	
Limiting values are given in accordance with the Absolute Maximum Rating System (IEC 134). Stress above one or more of the limiting values may cause permanent damage to the device. These are stress ratings only and operation of the device at these or at any other conditions above those given in the Characteristics sections of this specification is not implied. Exposure to limiting values for extended periods may affect device reliability.	
Application information	
Where application information is given, it is advisory and does not form part of the specification.	
© Philips Electronics N.V. 1999	
All rights are reserved. Reproduction in whole or in part is prohibited without the prior written consent of the copyright owner.	
The information presented in this document does not form part of any quotation or contract, it is believed to be accurate and reliable and may be changed without notice. No liability will be accepted by the publisher for any consequence of its use. Publication thereof does not convey nor imply any license under patent or other industrial or intellectual property rights.	

LIFE SUPPORT APPLICATIONS

These products are not designed for use in life support appliances, devices or systems where malfunction of these products can be reasonably expected to result in personal injury. Philips customers using or selling these products for use in such applications do so at their own risk and agree to fully indemnify Philips for any damages resulting from such improper use or sale.

Silicon **MAX**

N-channel TrenchMOS^(TM) transistor

PSMN070-200B; PSMN070-200P

NOTES

Philips Semiconductors – a worldwide company

Argentina: see South America

Australia: 3 Figtree Drive, HOMEBUSH, NSW 2140,
Tel. +61 2 9704 8141, Fax. +61 2 9704 8139

Austria: Computerstr. 6, A-1101 WIEN, P.O. Box 213,
Tel. +43 1 60 101 1248, Fax. +43 1 60 101 1210

Belarus: Hotel Minsk Business Center, Bld. 3, r. 1211, Volodarski Str. 6,
220050 MINSK, Tel. +375 172 20 0733, Fax. +375 172 20 0773

Belgium: see The Netherlands

Brazil: see South America

Bulgaria: Philips Bulgaria Ltd., Energoproject, 15th floor,
51 James Bourchier Blvd., 1407 SOFIA,
Tel. +359 2 68 9211, Fax. +359 2 68 9102

Canada: PHILIPS SEMICONDUCTORS/COMPONENTS,
Tel. +1 800 234 7381, Fax. +1 800 943 0087

China/Hong Kong: 501 Hong Kong Industrial Technology Centre,
72 Tat Chee Avenue, Kowloon Tong, HONG KONG,
Tel. +852 2319 7888, Fax. +852 2319 7700

Colombia: see South America

Czech Republic: see Austria

Denmark: Sydhavnsgade 23, 1780 COPENHAGEN V,
Tel. +45 33 29 3333, Fax. +45 33 29 3905

Finland: Sinikalliontie 3, FIN-02630 ESPOO,
Tel. +358 9 615 800, Fax. +358 9 6158 0920

France: 51 Rue Carnot, BP317, 92156 SURESNES Cedex,
Tel. +33 1 4099 6161, Fax. +33 1 4099 6427

Germany: Hammerbrookstraße 69, D-20097 HAMBURG,
Tel. +49 40 2353 60, Fax. +49 40 2353 6300

Hungary: see Austria

India: Philips INDIA Ltd, Band Box Building, 2nd floor,
254-D, Dr. Annie Besant Road, Worli, MUMBAI 400 025,
Tel. +91 22 493 8541, Fax. +91 22 493 0966

Indonesia: PT Philips Development Corporation, Semiconductors Division,
Gedung Philips, Jl. Buncit Raya Kav.99-100, JAKARTA 12510,
Tel. +62 21 794 0040 ext. 2501, Fax. +62 21 794 0080

Ireland: Newstead, Clonskeagh, DUBLIN 14,
Tel. +353 1 7640 000, Fax. +353 1 7640 200

Israel: RAPAC Electronics, 7 Kehilat Saloniki St, PO Box 18053,
TEL AVIV 61180, Tel. +972 3 645 0444, Fax. +972 3 649 1007

Italy: PHILIPS SEMICONDUCTORS, Via Casati, 23 - 20052 MONZA (MI),
Tel. +39 039 203 6838, Fax +39 039 203 6800

Japan: Philips Bldg 13-37, Kohnan 2-chome, Minato-ku,
TOKYO 108-8507, Tel. +81 3 3740 5130, Fax. +81 3 3740 5057

Korea: Philips House, 260-199 Itaewon-dong, Yongsan-ku, SEOUL,
Tel. +82 2 709 1412, Fax. +82 2 709 1415

Malaysia: No. 76 Jalan Universiti, 46200 PETALING JAYA, SELANGOR,
Tel. +60 3 750 5214, Fax. +60 3 757 4880

Mexico: 5900 Gateway East, Suite 200, EL PASO, TEXAS 79905,
Tel. +9-5 800 234 7381, Fax +9-5 800 943 0087

Middle East: see Italy

Netherlands: Postbus 90050, 5600 PB EINDHOVEN, Bldg. VB,
Tel. +31 40 27 82785, Fax. +31 40 27 88399

New Zealand: 2 Wagener Place, C.P.O. Box 1041, AUCKLAND,
Tel. +64 9 849 4160, Fax. +64 9 849 7811

Norway: Box 1, Manglerud 0612, OSLO,
Tel. +47 22 74 8000, Fax. +47 22 74 8341

Pakistan: see Singapore

Philippines: Philips Semiconductors Philippines Inc.,
106 Valero St. Salcedo Village, P.O. Box 2108 MCC, MAKATI,
Metro MANILA, Tel. +63 2 816 6380, Fax. +63 2 817 3474

Poland: Al.Jerozolimskie 195 B, 02-222 WARSAW,
Tel. +48 22 5710 000, Fax. +48 22 5710 001

Portugal: see Spain

Romania: see Italy

Russia: Philips Russia, Ul. Usatcheva 35A, 119048 MOSCOW,
Tel. +7 095 755 6918, Fax. +7 095 755 6919

Singapore: Lorong 1, Toa Payoh, SINGAPORE 319762,
Tel. +65 350 2538, Fax. +65 251 6500

Slovakia: see Austria

Slovenia: see Italy

South Africa: S.A. PHILIPS Pty Ltd., 195-215 Main Road Martindale,
2092 JOHANNESBURG, P.O. Box 58088 Newville 2114,
Tel. +27 11 471 5401, Fax. +27 11 471 5398

South America: Al. Vicente Pinzon, 173, 6th floor,
04547-130 SÃO PAULO, SP, Brazil,
Tel. +55 11 821 2333, Fax. +55 11 821 2382

Spain: Balmes 22, 08007 BARCELONA,
Tel. +34 93 301 6312, Fax. +34 93 301 4107

Sweden: Kottbygatan 7, Akalla, S-16485 STOCKHOLM,
Tel. +46 8 5985 2000, Fax. +46 8 5985 2745

Switzerland: Allmendstrasse 140, CH-8027 ZÜRICH,
Tel. +41 1 488 2741 Fax. +41 1 488 3263

Taiwan: Philips Semiconductors, 6F, No. 96, Chien Kuo N. Rd., Sec. 1,
TAIPEI, Taiwan Tel. +886 2 2134 2886, Fax. +886 2 2134 2874

Thailand: PHILIPS ELECTRONICS (THAILAND) Ltd.,
209/2 Sanpavuth-Bangna Road Prakanong, BANGKOK 10260,
Tel. +66 2 745 4090, Fax. +66 2 398 0793

Turkey: Yukari Dudullu, Org. San. Blg., 2.Cad. Nr. 28 81260 Umraniye,
ISTANBUL, Tel. +90 216 522 1500, Fax. +90 216 522 1813

Ukraine: PHILIPS UKRAINE, 4 Patrice Lumumba str., Building B, Floor 7,
252042 KIEV, Tel. +380 44 264 2776, Fax. +380 44 268 0461

United Kingdom: Philips Semiconductors Ltd., 276 Bath Road, Hayes,
MIDDLESEX UB3 5BX, Tel. +44 208 730 5000, Fax. +44 208 754 8421

United States: 811 East Arques Avenue, SUNNYVALE, CA 94088-3409,
Tel. +1 800 234 7381, Fax. +1 800 943 0087

Uruguay: see South America

Vietnam: see Singapore

Yugoslavia: PHILIPS, Trg N. Pasica 5/v, 11000 BEOGRAD,
Tel. +381 11 3341 299, Fax.+381 11 3342 553

For all other countries apply to: Philips Semiconductors,
International Marketing & Sales Communications, Building BE-p, P.O. Box 218,
5600 MD EINDHOVEN, The Netherlands, Fax. +31 40 27 24825

Internet: <http://www.semiconductors.philips.com>

© Philips Electronics N.V. 2000

SCA 69

All rights are reserved. Reproduction in whole or in part is prohibited without the prior written consent of the copyright owner.

The information presented in this document does not form part of any quotation or contract, is believed to be accurate and reliable and may be changed without notice. No liability will be accepted by the publisher for any consequence of its use. Publication thereof does not convey nor imply any license under patent- or other industrial or intellectual property rights.

Printed in The Netherlands

603502/300/03/pp12

Date of release: August 1999

Document order number: 9397 750 06972

Let's make things better.

Philips
Semiconductors



PHILIPS